

MotionCam Fibra Benutzerhandbuch

Aktualisiert am 4. Mai 2023



MotionCam Fibra ist ein kabelgebundener Bus-Bewegungsmelder mit Unterstützung für die Fotoverifizierung. Wird in Innenräumen installiert. Erkennt Bewegungen in einer Entfernung von bis zu 12 Metern; Ignoriert Haustiere, wenn sie korrekt installiert und konfiguriert sind. Der Melder ist in zwei Versionen erhältlich: mit und ohne **Fotounterstützung (auf Anfrage)**.



Der Melder ist kompatibel mit [Hub Hybrid \(2G\)](#) und [Hub Hybrid \(4G\)](#). Verbindung zu anderen [Hubs](#), [Funk-Range-Extender](#), [ocBridge Plus](#) und [uartBridge](#) ist nicht vorgesehen.

MotionCam Fibra arbeitet als Teil des Ajax-Sicherheitssystems und tauscht Daten mit der Hub-Zentrale über das sichere Fibra-Protokoll aus. Die kabelgebundene Kommunikation hat eine Reichweite von bis zu 2.000 Metern, wenn sie über ein Twisted-Pair-U/UTP-Cat.5-Kabel angeschlossen wird.

MotionCam Fibra ist das Gerät der neuen kabelgebundenen Fibra-Produktlinie. Solche Geräte können nur von akkreditierten Ajax-Partnern gekauft, installiert und verwaltet werden.

Funktionselemente

Kapitel in Arbeit

Funktionsprinzip

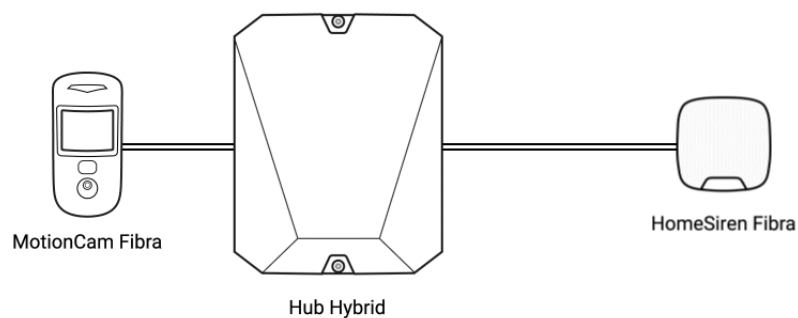

MotionCam Fibra ist ein kabelgebundener Bewegungsmelder mit Unterstützung für die Fotoverifizierung. Es erkennt ein Eindringen in den gesicherten Bereich und erfasst bewegte Objekte mit einer Temperatur, die der des menschlichen Körpers nahe kommt.

Nach der Erkennung von Bewegungen nehmen die Melder eine Reihe von Bildern auf, mit denen Sie dynamisch beurteilen können, was in der Einrichtung passiert. Das entlastet die Nutzer von unnötigen Ängsten und die Sicherheitsunternehmen von unnötigen Patrouillenfahrten.

Die eingebaute Kamera kann zwischen 1 und 5 Bilder mit einer Auflösung von 320×240 und bis zu 3 Bilder mit einer Auflösung von 640×480 Pixeln im Alarmfall aufnehmen, auf Anfrage und je nach Szenario.



Der Melder ist in zwei Versionen erhältlich: mit und ohne **Fotounterstützung (auf Anfrage)**.

A series of photos is reproduced in the app as an animation. Photos are available both in Ajax apps and on the security company's monitoring station software.

How Ajax notifies users of alerts

Learn more about Ajax motion detectors

For shooting in the dark, the detector is equipped with infrared illumination, which is activated when taking photos in low light.

The time it takes to deliver a photo to Ajax apps depends on the image resolution and the speed of the Internet connection. In this case, the alarm signal is transmitted in 0.15 seconds.

The table shows the delivery time for one photo when the signal strength between the hub and MotionCam Fibra is 2–3 bars and the hub is connected via Ethernet or 4G.

Photo resolution	Delivery time
160 × 120	TBC up to 7 seconds
320 × 240 (default)	TBC up to 9 seconds
640 × 480	TBC up to 20 seconds

Users know exactly where motion is detected. The notifications contain the name of the hub (the name of the protected facility), the name of the device, and the virtual room, to which the detector is assigned.

The detector does not go into armed mode instantly. The transition time to armed mode depends on two factors: the exit delay (specified in the detector settings) and the hub–detector ping period (Fibra settings, set automatically).

In the first case, the delay is set by the administrator or PRO user with administrator rights. In the second case, the delay occurs because the hub does

not notify the detector about switching to armed mode instantly but within one ping period.

Visual alarm verification in Ajax apps

Photos have been taken when an alarm is raised.

If “**Send photo when the alarm is raised**” option is enabled in the MotionCam Fibra settings, the detector alarms in Ajax apps are accompanied by photos or animations.

To view the received photos, click on the alarm notification in the events feed.

To save the photo, click on the button highlighted in the screenshot below.

A series of photos is played in the app as an animation, which allows you to dynamically assess the incident.

Each frame of a series of photos can be saved individually as well as the entire series at a time or MP4 video.

Features of the photo verification of alarms of MotionCam Fibra detectors

Photo by request

Chapter in progress

Photo by scenario

Chapter in progress

Temperature compensation

The detector perceives a person and other objects as heat spots. The device monitors these heat spots and signals an alarm if they move. MotionCam Fibra

reacts to the movement of heat spots whose temperature is close to that of the human body.

In case the ambient temperature is approximately equal to the temperature of the human body, the correct operation of the detector is not guaranteed unless temperature compensation is applied. Temperature compensation is used in all Ajax motion detectors. Thanks to this, the detector detects movement over the entire operating temperature range.

[Learn more about temperature compensation](#)

Pet immunity

If configured and installed correctly, MotionCam Fibra does not respond to pets up to 50 centimeters tall and weighing up to 20 kilograms.

The detector is installed at a height of 2.4 meters without obstacles for the detector's view— for example, in the corner of a room, where the view will not be blocked by a wardrobe or other furniture that a pet can climb on.

The correct setting presupposes the choice of the required detector sensitivity:

- **High** – the detector disregards cats (under 25 cm).
- **Medium** – the detector disregards small dogs (under 35 cm).
- **Low** – the detector disregards animals under 50 cm.

When indoor motion detectors are installed below the recommended height, animals move in the sensitive area. The detector can raise an alarm if a German shepherd dog walks on its hind legs or even a small spaniel plays on an armchair. The detector will also raise an alarm if the animal jumps to the level of the detector or move around it.

[Why motion detectors react to animals and how to avoid it](#)

[How to install MotionCam Fibra correctly](#)

Fibra data communication protocol

MotionCam Fibra uses Fibra technology to transmit alarms, events, and photos. Fibra is a two-way wired data transfer protocol that provides fast and reliable communication between the hub and connected devices in the system. Using the bus connection method, Fibra delivers data instantly, even if 100 detectors are connected to the hub.

Fibra supports floating key block encryption and device recognition on every session to prevent sabotage and device spoofing. The protocol provides for regular pings of detectors by the hub to monitor communication and display their statuses in real time in Ajax apps.

[Learn more about the Fibra protocol](#)

Sending events to the monitoring station

The Ajax security system can transmit alarms to the [PRO Desktop](#) monitoring app and to the Central Monitoring Station (CMS) in **SurGard (Contact ID)**, **ADEMCO 685, SIA (DC-09)**, and other proprietary protocols formats. A complete list of supported protocols is [available here](#).

[Which CMSs can Ajax Hubs be connected to?](#)

MotionCam Fibra transmits the following events to the monitoring station:

1. Motion alarm
2. Visual alarm verification
3. Tamper alarm / restore
4. Loss/restoration of connection with the hub
5. Temporary enabling/disabling of the detector
6. Unsuccessful attempt to arm the security system (with the [integrity check](#) enabled).

When an alarm is received, the operator of the security company knows exactly what happened and where exactly in the facility it is necessary to send a rapid response team. The addressability of each Ajax device allows sending not only events to PRO Desktop or the CMS but also the type of device, the name

assigned to it, and the room in which it is located. Note that the list of transmitted parameters may differ depending on the type of CMS and the selected protocol for communication with the monitoring station.



The device ID, loop (zone) number, and bus number can be found in their [states in the Ajax app](#).

Photos are transmitted to the control panel of the security company if the CMS software supports the transmission of visual alarm verification. The list of CMSs that support Ajax photo verification is [available here](#).



Visual alarm verifications are available on the [PRO Desktop CMS](#) without additional configuration.

Location election

When choosing the location of the detector, consider the parameters that affect the operation of the device:

- Fibra signal strength
- The length of the wired connection
- Motion detector detection area
- Detection angle of the detector camera and the presence of interference in front of it

Consider the recommendations for placement when developing a project for the security system of the facility. The security system must be designed and installed by accredited specialists. A list of recommended partners is [available here](#).

Design and preparation

For the system devices to work correctly, it is necessary to draw up a project properly and install all detectors. Violation of the basic rules of installation and recommendations of the user manual can lead to incorrect operation of detectors or loss of communication with installed devices.

When designing the layout of the devices, consider the routing layout of the power cables laid on the facility. Signal cables must be laid at a distance of at least 50 cm from power cables when laying in parallel. Observe a 90° angle between the crossing conductors. If you are connecting multiple devices on the same bus, keep in mind that they are connected in series.



Up to 100 devices can be connected to the Hub Hybrid at default settings.

[How to calculate the number of connected detectors \(in progress\)](#)

Security cables at facilities that are under construction or renovation are laid after the installation of the facility's electrical wiring. Do not allow the conductors to sag. Use ties, clips, staples, and protective tubes to organize and secure them.

For greater safety, it is recommended to run cables inside walls, floors, and ceilings. This will provide greater security; the cables will not be visible, and an intruder will not be able to reach them.

When routing cables outside (not inside the walls, floors, or ceilings), use a cable duct or protective corrugation. Do not fill the cable duct or protective corrugation more than half full with cables. The cable duct box should be hidden from prying eyes as much as possible—for example, behind furniture.

When choosing the type of cable, consider the length of the connecting lines and the number of connected detectors since these parameters affect the signal quality. We recommend using shielded copper cables with a high-quality insulating layer.

Check cables for kinks and physical damage before installation. During installation, observe the bending radius, which the manufacturer indicates in the characteristics of the cable. Otherwise, you risk damaging or breaking the conductor.

Signal strength and cable length

The Fibra signal strength is determined by the number of undelivered or corrupted data packets over a certain time. The signal strength is indicated by the icon in the **Devices** tab: 

- **Three bars** mean excellent signal strength.
- **Two bars** mean good signal strength.
- **One bar** indicates low signal strength; stable operation is not guaranteed.
- **A crossed-out icon** means no signal.

The quality and signal strength are influenced by such factors as the number of detectors connected to one bus, the length and type of cable, and the quality of the wire connection to the terminals.



Check the Fibra signal strength before the final installation of the detector. If the signal strength is one or fewer bars, we do not guarantee stable operation of the device.

The permissible cable length depends on the cable type and material. When connected via the **Beam (Radial) connection** using the U/UTP cat.5 (4x2x0.51) twisted pair, the length of the wired connection can reach up to 2,000 meters.

When devices are connected via the **ring connection method**, the maximum cable length is 500 meters in case of using a twisted pair.

How to calculate the length of a wired connection (in progress)



Connecting devices using the **ring connection method** will be available with future OS Malevich updates. Hardware update of Hub Hybrid won't be required.

[How OS Malevich updates](#)

Detection area

The area of the monitored territory and the effectiveness of the security system depend on the location of the detector. When selecting the installation location, consider the direction of the lens, the detection angles of the detector, and the presence of obstacles impairing the view.

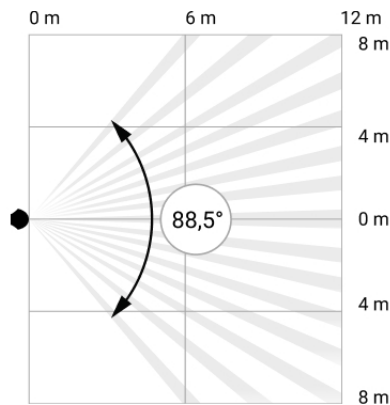

Detection angle, horizontal

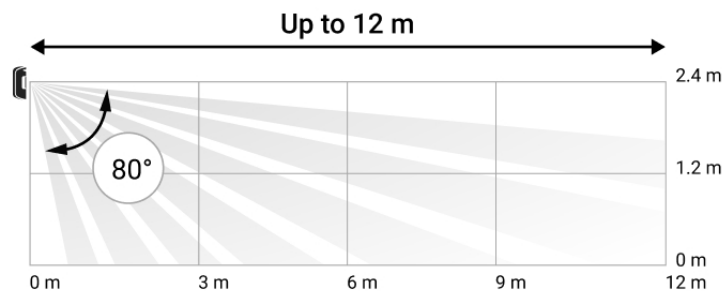

Detection angle, vertical

The direction of the detector lens should be perpendicular to the intended path of forced entry into the room. Furniture, houseplants, vases, and ornamental and glass structures should not obstruct the field of view of the detector or its camera.

When installing the detector, perform the Detection Zone Test. This allows you to check the operation of the device and accurately determine the sector in which the detector reacts to movement. If possible, take a couple of photos at the installation site to make sure that the camera is capturing the desired area and that no obstructions are blocking its view.

Where the detector should not be installed

1. Outdoors. This can lead to false alarms and damage to the detector.

2. Facing the window to avoid direct sun rays hitting the detector lens. This can lead to false alarms of the motion detector.
3. Opposite facilities with rapidly changing temperatures— for example, electric and gas heaters. This can lead to false alarms of the motion detector.
4. Opposite any moving objects characterized by a temperature close to that of the human body— for example, opposite the swinging curtains above a radiator. This can lead to false alarms of the motion detector.
5. Near places with fast air circulation— for example, fans, open windows, or doors. This can lead to false alarms of the motion detector.
6. In places where objects and structures may obstruct the detector's view— for example, behind a flower or a column. This may impair the performance of the detector.
7. In places where glass structures may obstruct the detector's view. The detector does not detect movement behind glass.
8. Inside premises with temperature and humidity outside the permissible limits. This can damage the detector.

Installation and connection



Before installing the MotionCam Fibra, ensure that you have selected the optimal location that complies with the requirements of this manual. The cables should be hidden from prying eyes and located in a place that is difficult for burglars to access to reduce the likelihood of sabotage. Ideally, mount them in the walls, floors, or ceilings. Perform [Fibra detection zone](#) and [signal strength tests](#) before final installation.

When connecting to the device terminals, do not twist the wires together; solder them. The ends of the wires that will be inserted into the terminals should be tinned or crimped with special tips. This will ensure a reliable connection. **When installing, follow the safety precautions and the electric installation work rules.**

In order to mount a detector:

1. Switch off the control panel. Disconnect the hub external power supply and the backup battery.

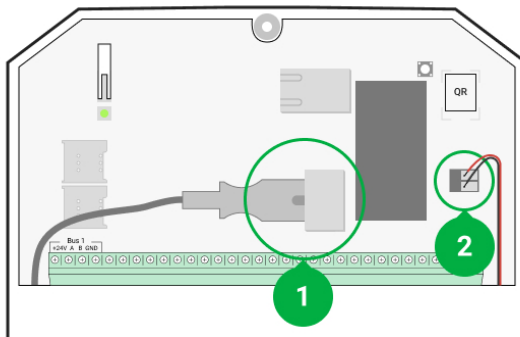

- 1 – External power supply
- 2 – Backup battery

2. Route the cable into the hub, and connect the wires to the bus terminals.

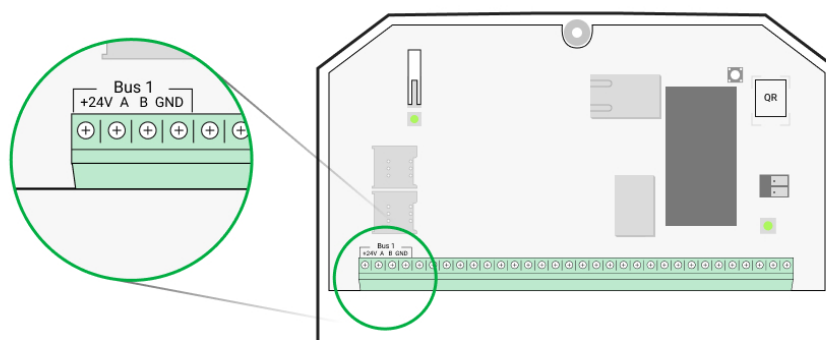

- +24V** – power supply input
- A, B** – signal terminals
- GND** – ground

3. Remove the SmartBracket mounting panel from the detector. Carefully break off or drill a piece of the mount to output the wires.
4. Route the wire from the hub into the detector enclosure through the made hole.
5. Connect the wires to the terminals according to the diagram below. When connecting, observe the polarity and order of the wires. Fix the cable securely in the terminals.

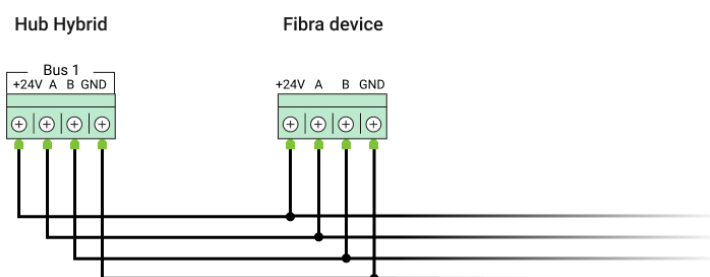

+24V – power supply input

A, B – signal terminals

GND – ground

6. If the detector is not the last one in the connection line, prepare a second cable in advance. The ends of the wires of the first and second cables, which will be inserted into the detector terminals, must be tinned and soldered together, or crimped with special tips.
7. If the **Beam (Radial) connection** is used, install a terminating resistor by connecting it to the signal terminals of the device. When the **Ring connection method** is used, a terminating resistor is not needed.



We recommend using the **Ring connection method** (hub – device – hub). If the ring is broken, not a single device will be disabled. In this case, two beams are formed, which will continue to operate normally and transmit events to the hub. If the ring is broken, the users and security company receive notification.



[More about detector connection topologies \(in progress\)](#)

8. Temporarily fix the SmartBracket panel to a vertical surface or in a corner using double-sided adhesive tape or other temporary fasteners. The height of the installation is 2.4 meters.
9. Turn on the hub to supply power to the connected detector. The MotionCam Fibra LED will blink when turned on.
10. Add the detector to the system.
11. Perform the Fibra signal strength test. The recommended value for the signal strength is two or three bars. Otherwise, check the connection and the integrity of the cable.

12. Perform a [Detection zone test](#). In order to check the motion detector, walk around the premises while observing the LED and determine the detection zone of the detector. The maximum range of motion detection by the detector is 12 meters. If the detector did not respond to movement during the test in 5 out of 5 cases, relocate the device.
13. Take some test photos to make sure that the camera is capturing the desired area and that no obstacles are blocking its view.
14. Fasten the SmartBracket panel with the bundled screws using at least two fixation points (one of them is in the perforated part of the mount above the tamper). When choosing other fasteners, make sure they do not damage or deform the mounting panel.



Use double-sided adhesive tape for temporary attachment only. The device attached by adhesive tape can come unstuck from the surface at any time. While the device is attached to the adhesive tape, the tamper will not work when the detector detaches from the surface.

15. Place the detector on the SmartBracket mounting panel and fix it with the screw.

Adding to the system



The detector is compatible with [Hub Hybrid \(2G\)](#) and [Hub Hybrid \(4G\)](#) only. Adding and configuring Fibra devices are available only in PRO Ajax apps.

[Types of accounts and their rights](#)

Before adding a device

1. Install the [Ajax PRO app](#). Create an [account](#), if you didn't have one. Add a compatible hub to the app, make the necessary settings, and create at least one [virtual room](#).
2. Make sure that the hub is turned on and has access to the internet via Ethernet and/or mobile network. This can be done in the Ajax app or by

looking at the LED indicator on the hub board. It should be a white or green light.

3. Make sure the hub is not armed and is not updating by looking at its status in the Ajax app.
4. Make sure the detector is physically connected to the hub.

How to add MotionCam Fibra

There are several ways to add detectors through the [Ajax app](#): Manually and automatically are available.

To add a detector manually:

1. Open the [Ajax PRO app](#). Select the hub where you want to add MotionCam Fibra.
2. Go to the **Devices** tab and click **Add device**. 
3. Name the detector, scan or enter the QR code (located on the detector body and packaging), select a room and a group (if [group mode](#) is enabled).
4. Click **Add**.

To add the detector automatically:

1. Open the [Ajax PRO app](#). Select the hub where you want to add MotionCam Fibra.
2. Go to the Devices tab and click Add device. 
3. Select **Add all bus devices**. The hub will scan all buses. After scanning, a list of all devices connected to the hub that have not yet been added to the system will appear on the screen. The detectors are sorted according to the buses to which they are physically connected.

After scanning the buses, the detectors will be displayed in the **Devices** tab. The order of the devices will depend on which bus they are connected to. 

By default, the device name includes the detector name and its ID. To bind a detector to a hub, edit its name, and assign a room and a group to it (if group mode is activated in the hub settings).

To check which detector you want to add exactly, we have provided two methods: LED indication and detector triggering.

Method 1: By LED indication

Click on any of the devices in the list of those available for adding. After this, the LED indicator of this detector will start blinking. Now, you will know exactly which detector you are adding, how to name it, and to which room and group it needs to be linked.

To add a detector:

1. Click on the device in the list.
2. Enter a name.
3. Specify the room and security group (if enabled).
4. Click **Save**.

If the detector has successfully bound to the hub, it will disappear from the list of available ones.

Method 2: By detector alarm

Provoke an alarm by opening a door or window that protects the detector. Once triggered, the detector will move to the top of the list in the **Triggered devices** category. The detector will remain in this category for 5 seconds, after which it will be moved back to the bus category.

To add a detector:

1. Click on the device in the list.
2. Enter a name.
3. Specify the room and security group (if enabled).
4. Click **Save**.

If the detector has successfully bound to the hub, it will disappear from the list of available ones.



Updating device statuses depends on Fibra settings, the default value is 36 seconds.

The detector connected to the hub will appear in the list of hub devices in the Ajax app.

If the connection fails, check the correctness of the wired connection and try again. If the maximum number of devices has already been added to the hub (100 devices according to default settings for Hub Hybrid), you will receive a corresponding notification when you try to add.

The MotionCam Fibra only works with one hub. When connected to a new hub, the detector stops transmitting commands to the old hub. Once added to a new hub, the MotionCam Fibra is not removed from the devices list of the old hub. This must be done through the Ajax app.

Malfunctions

Chapter in progress

When the detector detects a malfunction (for example, there is no communication via the Fibra protocol), a malfunction counter is displayed in the Ajax app in the upper left corner of the device icon.

All malfunctions can be seen in the detector states. Fields with malfunctions will be highlighted in red.

The fault is displayed if:

- The detector temperature is out of range.
- The detector body is open (tamper actuation).
- There is no connection with the hub via the Fibra protocol.

Icons

Chapter in progress

The icons represent some of the states of MotionCam Fibra. You can see them in the Ajax app in the **Devices** tab. 

Statuses

Chapter in progress

The statuses include information about the device and its operating parameters. The statuses of MotionCam Fibra can be found in the Ajax app:

1. Go to the **Devices** tab. 
2. Select MotionCam Fibra from the list.

Parameter	Value
Temperature	Detector temperature. Measured at the site of the processor and changes gradually
Fibra signal strength	<p>The signal strength between the hub and the MotionCam Fibra. Recommended value is 2–3 bars.</p> <p>Fibra is a protocol for the transmission of MotionCam Fibra events and alarms.</p> <p>Learn more</p>
Connection via Fibra	<p>The status of the connection between the hub and the detector:</p> <ul style="list-style-type: none">• Online – the detector is connected to the hub.• Offline – the detector has lost connection with the hub.
Bus voltage	<p>Total bus voltage value:</p> <p>Low value – 7 V</p> <p>Maximum allowable – XX V</p>



Lid	The status of the detector's tamper that responds to detachment or violation of the integrity of the body
Delay When Entering, sec	<p>Entry delay. Entry delay (alarm activation delay) is the time you have to disarm the security system after entering the premises.</p> <p><u>Learn more</u></p>
Delay When Leaving, sec	<p>Delay upon exiting. Exit delay (alarm activation delay) is the time you have to exit the premises after the security system is armed.</p> <p><u>Learn more</u></p>
Night mode entry delay, sec	<p>Entry delay time in Night mode. Entry delay (alarm activation delay) is the time you have to disarm the security system after entering the premises.</p> <p><u>Learn more</u></p>
Night mode exit delay, sec	<p>Exit delay time in Night mode. Exit delay (alarm activation delay) is the time you have to exit the premises after the security system is armed.</p> <p><u>Learn more</u></p>
Sensitivity	The level of sensitivity of the motion detector
Always active	<p>When activated, the detector is always in armed mode.</p> <p><u>Learn more</u></p>
Temporary disabling	<p>Shows the status of the function to temporarily disable the device:</p> <ul style="list-style-type: none"> • No – the device operates normally and transmits all events. • Lid only – the hub administrator has disabled notifications about triggering on

	<p>the body.</p> <ul style="list-style-type: none"> • Completely – the device is completely excluded from the system by the hub administrator. The device does not execute system commands and does not report alarms or other events. • By the number of alarms – the device is automatically disabled when the number of alarms is exceeded (specified in the settings for Automatic disabling of devices). The feature is configured in the Ajax PRO app. <p>Learn more</p>
Firmware	Detector firmware version
ID	Device ID

Configuration

Chapter in progress

To change the settings of the MotionCam Fibra detector in the Ajax app:

1. Go to the **Devices** tab. 
2. Select MotionCam Fibra from the list.
3. Go to **Settings** by clicking on the gear icon. 
4. Set the required parameters.
5. Click **Back** to save the settings.

Configuration	Value
First field	Name of the detector, which can be changed
Room	The choice of the virtual room that the device is assigned to

<p>Delay When Entering, sec</p>	<p>Selecting the entry delay period. Entry delay (alarm activation delay) is the time you have to disarm the security system after entering the premises.</p> <p><u>What is entry delay?</u></p>
<p>Delay When Leaving, sec</p>	<p>Selecting the exit delay period. Exit delay (alarm activation delay) is the time you have to exit the premises after the security system is armed.</p> <p><u>What is exit delay?</u></p>
<p>Arm in night mode</p>	<p>When enabled, the detector will enter the armed mode when the system is set to Night mode.</p> <p><u>What is Night mode?</u></p>
<p>Night mode entry delay, sec</p>	<p>Entry delay time in Night mode.</p> <p>Entry delay (alarm activation delay) is the time you have to disarm the security system after entering the premises.</p> <p><u>What is entry delay?</u></p>
<p>Night mode exit delay, sec</p>	<p>Exit delay time in Night mode.</p> <p>Exit delay (alarm activation delay) is the time you have to exit the premises after the security system is armed.</p> <p><u>What is exit delay?</u></p>
<p>LED indication of alarms</p>	<p>When disabled, the detector LED will not signal an alarm or tamper triggering</p>
<p>Sensitivity</p>	<p>The MotionCam Fibra detector has three sensitivity levels. The choice depends on the type of facility, the presence of probable sources of false alarms, and the protected zone:</p> <ul style="list-style-type: none"> • Low – disregards animals under 50 cm.

	<ul style="list-style-type: none"> • Medium (default) – disregards small dogs (under 35 cm). • High – disregards cats (under 25 cm). <p><u>Why motion detectors react to animals and how to avoid it</u></p>
Always active	<p>When the option is enabled, the detector is constantly armed and detects movement.</p> <p><u>Learn more</u></p>
Resolution of images	<p>MotionCam Fibra takes photos with the following resolutions:</p> <ul style="list-style-type: none"> • 160 × 120 • 320 × 240 • 640 × 480 <p>The higher the resolution, the more detailed the image is, but it takes longer to transfer the photos to the hub.</p>
Sending of photos when alarm is raised	<p>When triggered, the detector takes from 1 to 5 photos.</p> <p>If the Disable option is selected, the detector does not activate the camera when alarms are raised.</p>
Alarm with photo verification	<p>MotionCam Fibra can take photos whenever an alarm is raised or only during the first 1–10 activations. The limit is reset once the security system is disarmed.</p>
Alert with a siren if motion is detected	<p>When enabled, <u>sirens connected to the system</u> are activated when motion is detected by this detector.</p>
Fibra signal strength test	<p>Switches the detector to the Fibra signal strength test mode.</p> <p>The test allows you to check the signal strength between the hub and the detector using the</p>

	<p>Fibra wired data transfer protocol to determine the optimal installation location.</p> <p><u>Learn more</u></p>
Detection zone test	<p>Switches the detector to the detection zone test mode. The test enables users to check how the detector responds to the movement and determines the optimal installation location.</p> <p><u>Learn more</u></p>
User Manual	<p>Opens the detector User Manual</p>
Temporary disabling	<p>Allows the user to disconnect the device without deleting it from the system.</p> <p>Two options are available:</p> <ul style="list-style-type: none"> • Completely – the device will not execute system commands and participate in automation scenarios, and the system will ignore alarms and other device notifications • Lid only – the system will only ignore notifications about device tamper button triggering <p><u>Learn more about temporarily disabling devices</u></p> <p>The system can also automatically disable devices when the set number of alarms is exceeded.</p> <p><u>Learn more about automatic device disabling</u></p>
Unpair device	<p>Unpairs the detector, disconnects it from the hub, and deletes its settings</p>

Indication



The MotionCam light indicator may light up red or green depending on the status of the device.

Indication	Event
Lights up green once when power is connected.	The detector is on.
Lights up green for about 1 second.	Motion alarm/tamper alarm. <div data-bbox="820 535 1418 680" style="border: 1px solid black; border-radius: 10px; padding: 10px; margin-top: 10px;"> The detector detects movement every 5 seconds.</div>

Functionality testing

The Ajax security system provides several tests for choosing the correct location for installing devices. MotionCam Fibra tests do not start instantly, but after no more than one hub–detector ping period (36 seconds at standard hub settings). You can change the ping period for devices in the **Fibra** menu in the hub settings.

To run a test in an Ajax app:

1. Select the required hub.
2. Go to the **Devices** menu. 
3. Select the MotionCam Fibra.
4. Go to **Settings** . 
5. Select the desired test:
 1. Fibra signal strength
 2. Detection zones
6. Run and perform the test.

Maintenance

Check the functioning of the detector regularly. Clean the body of dust, cobwebs, and other contaminants as the need arises. Use a soft dry cloth that is suitable for equipment care.

Do not use substances that contain alcohol, acetone, gasoline, or other active solvents to clean the detector. Wipe the lens and detector's camera gently as scratches on the plastic can reduce the detector's sensitivity, and scratches on the camera can result in poor-quality pictures and damage to the camera.

Technical Specifications

[Learn more](#)

[Compliance with standards](#)

Complete Set

1. MotionCam Fibra
2. SmartBracket mounting panel
3. Installation kit
4. Quick Start Guide

Warranty

Warranty for the Limited Liability Company "Ajax Systems Manufacturing" products is valid for 2 years after purchase.

If the device does not function properly, we recommend that you first contact support services as technical issues can be resolved remotely in half of the cases.

[Warranty obligations](#)

Technical support contacts:

- [e-mail](#)
- [Telegram](#)

Subscribe to the newsletter about safe life. No spam

Subscribe